

CEILING FAN INSTALLATION MANUAL

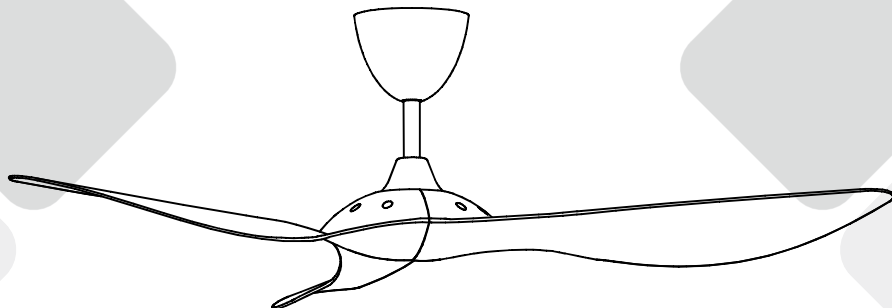

deka+[™]



Thank you for purchasing our product.
Before operating this set, please read these instructions completely.



Use only with rated voltage 220-240VAC / 50Hz



Switch off power supply and wait until the blade is fully static,
before cleaning or doing any maintenance jobs.



The appliance is not intended for use by persons (including children) with reduced physical,
sensory or mental capabilities, or lack of experience and knowledge, unless they have been
given supervision or instruction.

Children should be supervised to ensure that they do not play with the appliance.

Supplied Parts

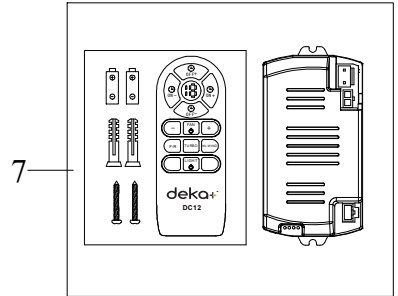
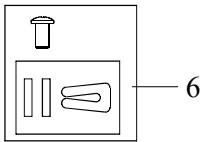
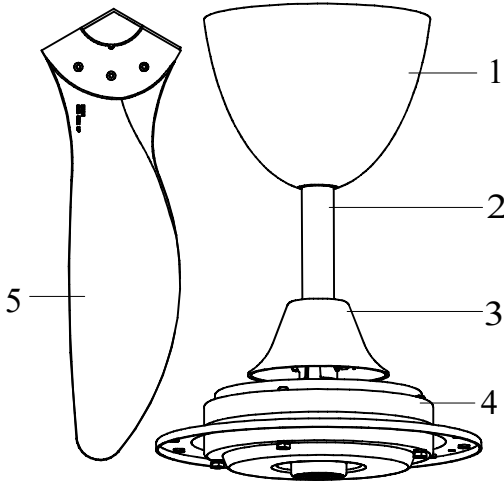

Item	Parts	QTY
1	Upper canopy	1 set
2	Downrod assembly	1 set
3	Lower canopy	1 set
4	Motor assembly	1 set
5	Blades (3 pcs)	1 set
6	Screw pack and balancing kit	1 set
7	Remote control & Receiver	1 set

How to Install the fan

The following steps will guide you to a successful installation

1. Downrod & lower canopy installation
2. Fan body installation
3. Ceiling fan assembly installation
4. Safety cable installation
5. Connecting the power supply
6. Upper canopy installation
7. Blades installation

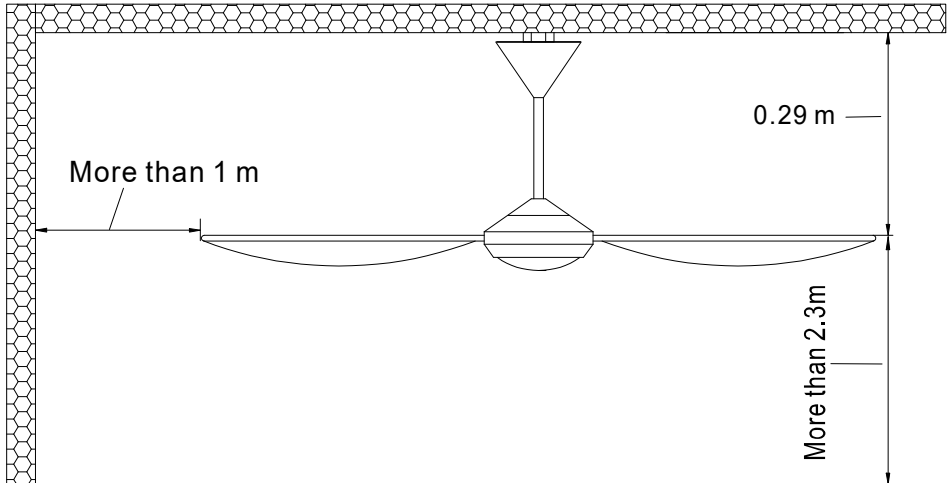

WARNING

Ceiling fan must be mounted above 2.3 m from the floor and 1 m from the wall to the blade

Fan Assemble Parts

Note: Downrod has been fully tighten to the Motor Shaft
(Bolt tightening torque is 250-300N*cm)

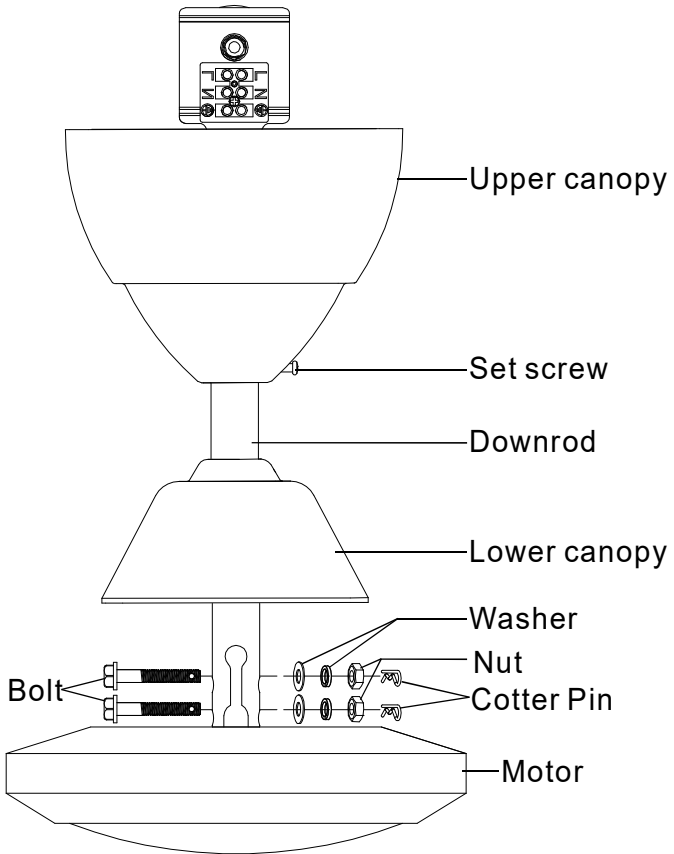

Install Fan Body

1. Remove the supplied bolt , wash , nut , pulley and cotter pin from the top portion of downrod.



WARNING

This Bolt must be firmly tightened.

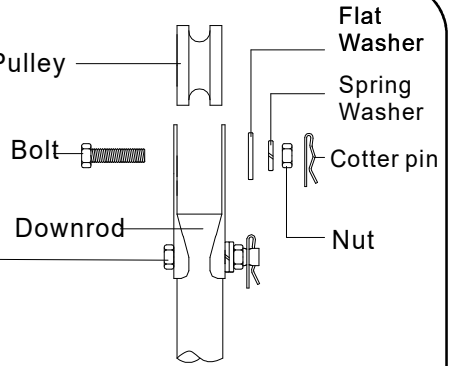

2. Place the pulley onto the hook .



WARNING

Ensure Hook can afford more than 10 times the ceiling fan weight

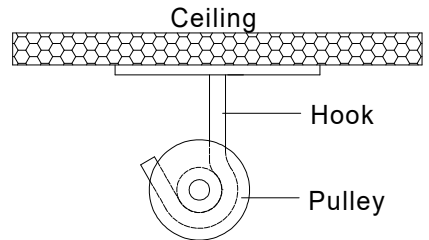

3. Fix and firmly tighten the previous bolt, washer, nut and cotter pin.



WARNING

Cotter Pin must insert into Bolt and Bent.

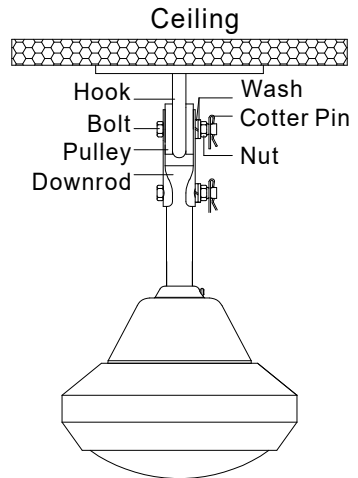

Install Safety Cable

1. Remove the safety cable screw from the downrod(Stp.1)
2. Arrange and tie the safety cable(Stp.2)
3. Firmly screw the safety cable onto the downrod(Stp.3).



WARNING
Safety Cable must fix correctly.
Can cause injury if ceiling fan drops.

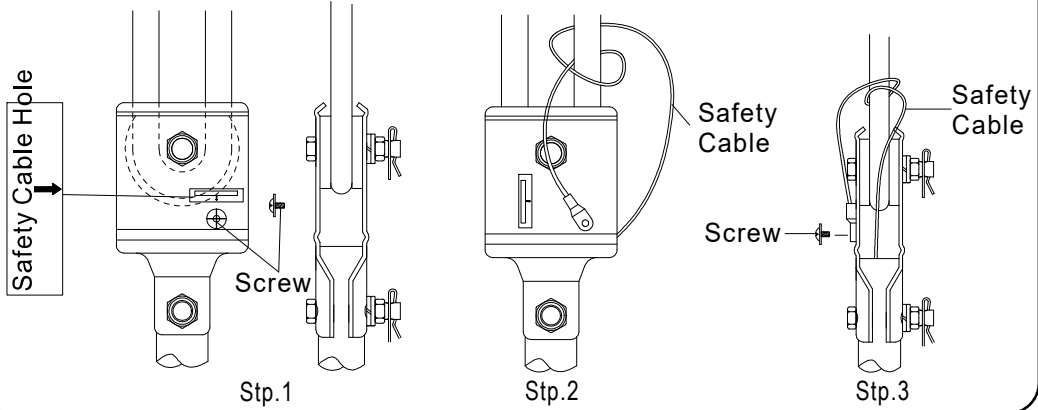

Connecting The Power Supply

Only direct connection to wall allowed. Please refer to figure below.

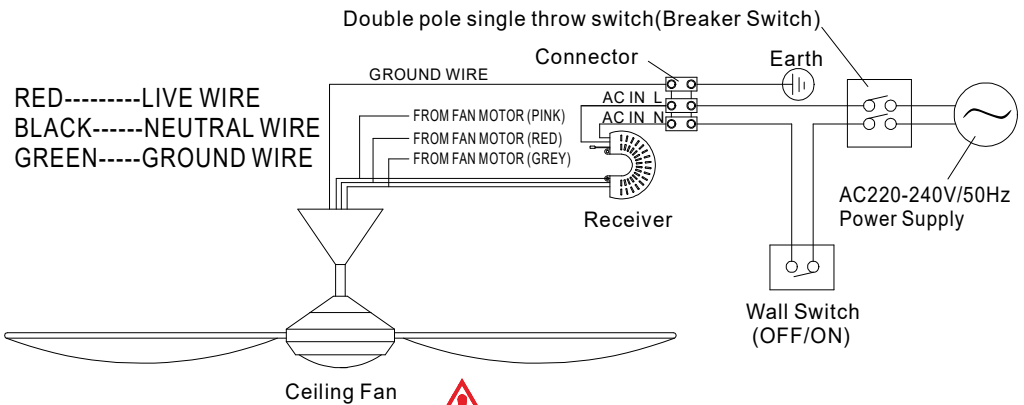

WARNING
This product is not provided with cord and plug or with other means for disconnection from the supply. When connect or change the power cord lead wire, it must be performed by qualified personnel in order to avoid a hazard. Please use wire thickness of cross section 1mm² or above.

Install Canopy

Type 1: For Full Canopy set

Raise the upper canopy and tighten it with the set screw .
Be sure the upper canopy is 10mm from the ceiling

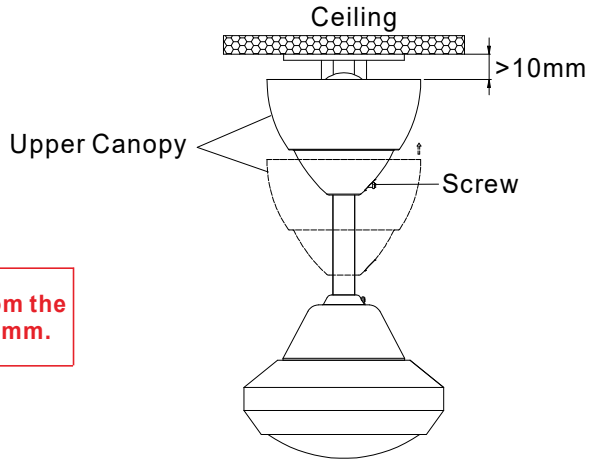

WARNING

Distance of Upper Canopy from the Ceiling must be more than 10 mm.

Type 2: For Side-Couple Canopy set

Raise the upper canopy and tighten it with the set screw .
Be sure the upper canopy is 10mm from the ceiling

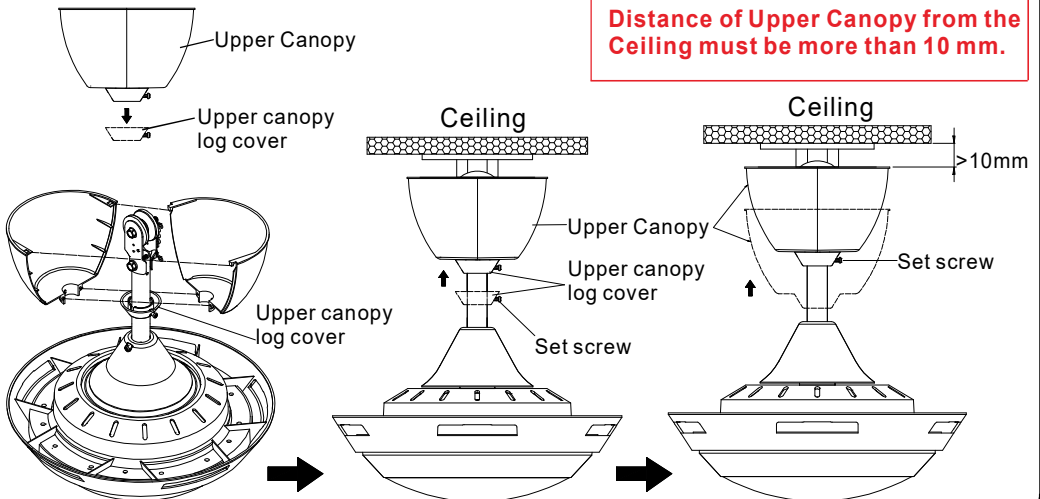

WARNING

Distance of Upper Canopy from the Ceiling must be more than 10 mm.

Install Blades

1. Tighten the blades with screws provided. Each Blade uses 3 pieces of screw .
2. Ensure the screws for securing the blades are tightly screwed.

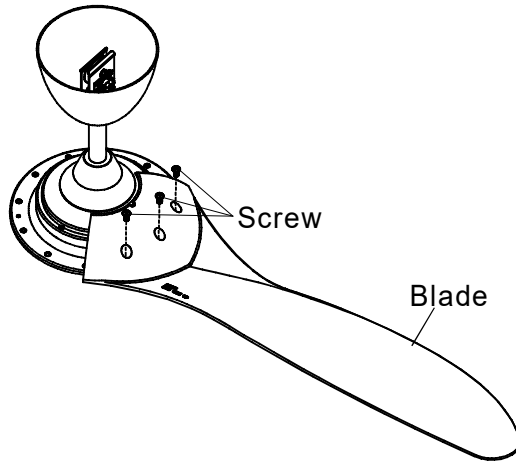





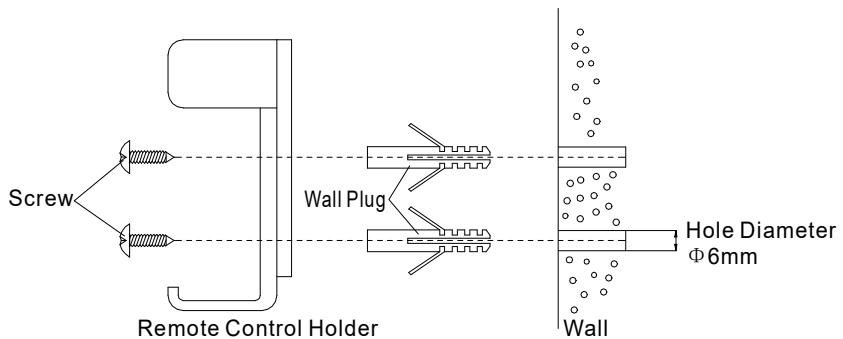

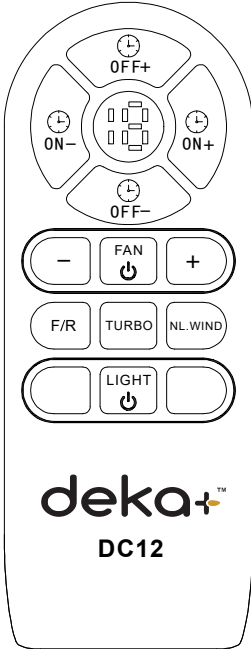

Install Remote Control Holder

Fix the Remote Control Holder to wall as figure below.
The Wall Plugs are not needed for wooden walls.

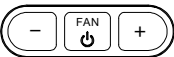

How To Use Remote control



Button	Function Description
 OFF +	Set the timer to turn OFF the fan from 0 Hr. to 12 Hr.
 OFF -	Set the timer to turn OFF the fan from 12 Hr. to 0 Hr.
 ON +	Set the timer to turn ON the fan from 0 Hr. to 12 Hr.
 ON -	Set the timer to turn ON the fan from 12 Hr. to 0 Hr.
	<p>“FAN” - Turn ON / OFF the fan. The fan will resume operation at the last speed setting before power off.</p> <p>“+” Set the fan speed from speeds 1 to speeds 12 .</p> <p>“-” Reduce the fan speed from speeds 12 to speeds 1.</p>
	<p>“LIGHT” - Turn ON / OFF light. (Only for LED models) Press light ON/OFF button continues 5s to change 3 types of light tone.</p>
	Set up the fan to forward or reverse ventilation.
	Set up the fan at highest speeds (Speed 12).
	This function will give the effect of natural wind blowing. (The fan will automatically increase speed from speed 1 to speed 12 every 10 seconds and from Turbo speed back to speed 1. Pressing this button again will cancel this function)

STEPS FOR LEARNING CODE : (REMOTE CONTROL PAIRING)

Learning code matching mode is used between emitter and receiver. Turn “ON” the supply power within 30 seconds and press the “TURBO” button for 5 seconds. After hearing a long sound “bee”, which means pairing is successfully and it can work normally.

(NOTE: Learning mode is not accepted after turn “ON” the supply power for 30 seconds.)

Remote Control Coverage

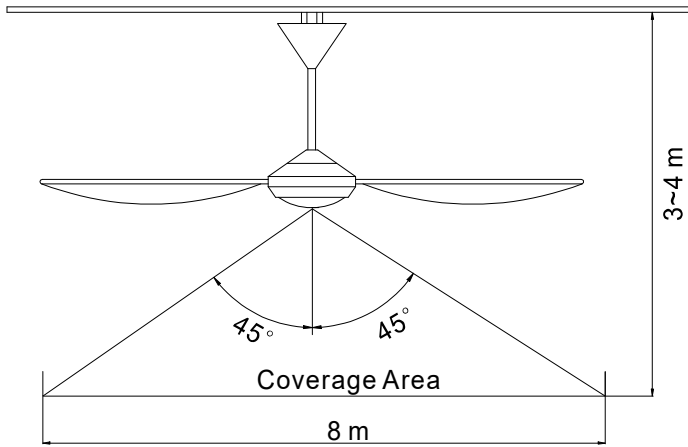

The figure shows the best coverage area. The ideal ceiling height is 3~4m.

How To Use The Balancing Kit

If the fan encounter wobbling during operation.
Do the following steps to solve the problem.

1. Tighten all screws.
2. Unscrew the blades and fix them back at different combination of position on the motor.
3. Measure the level between the ceiling and all blades.
4. Use the blade balancing kit provided if the fan still wobbles.

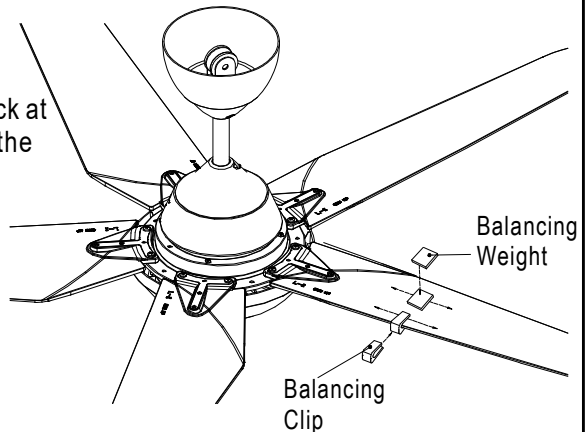

Maintenance

Due to fan natural movement, connections may get loose after a period of usage. To ensure a proper and safety usage is highly recommended to inspect and tighten all connections in every 6 months.

CLEANING

Clean your fan periodically to maintain its new appearance. Basic cleaning procedures are as follows:

1. Use only lukewarm water, Do Not use detergent, corrosive or acidic solution.
2. Damp the cloth lightly . Use only soft or lint-free cloth to clean the fan. Rough fabric will scratch the surface.
3. Apply a thin coat of furniture polish to the wooden blades will protect and enhance the appearance.
4. To cover small scratches, apply a light coat of shoe polish over it
5. There is no need to oil the fan.

Troubleshooting

Check on the following before lodging a service report

PROBLEM	CAUSE	SOLUTION
Fan not moving	<ol style="list-style-type: none">1. Main cables not connected2. Wire connection loose	<ol style="list-style-type: none">1. Check mains and branch circuit breakers or fuse2. Check the line wires connections to the fan and switch housing
Fan noisy	<ol style="list-style-type: none">1. Housing screws are loose2. Wire and nut connections rattles against each other3. Canopy touches the ceiling	<ol style="list-style-type: none">1. Tighten all screws2. Separate and store neatly the wire connections from the nut3. Check that the canopy is not touching or too close to the ceiling
Remote Control not working	<ol style="list-style-type: none">1. Remote and receiver code different2. Battery not installed3. Weak battery	<ol style="list-style-type: none">1. Refer page 9, repairing the remote learning code2. Install the remote control battery3. Change a new battery

Customer Service Centre

If you need any technical assistance or to report a fault, please contact our customer service centre at:

DEKA MARKETING SDN BHD

200901029313 (872418-P)

No.7, JALAN UDANG HARIMAU 1,
MEDAN NIAGA KEPONG,
51200 KUALA LUMPUR,
MALAYSIA.



TEL: 603-62426166 (Hunting Line)

FAX: 603-62424822

Service hotline: 603-62421600 (Hunting Line)

Web: [http:// www.deka.my](http://www.deka.my)



WARNING

Ceiling fan are not recommended to be install directly above heating area, such as stove, oven, hot plate and others. This will shorten the lifespan due to direct heat and oil cause by cooking.

Specifications, T40

VOLTAGE	FAN POWER	LIGHTING POWER	SIZE OF FAN
220-240V~50Hz	45 watts	/	1400mm
220-240V~50Hz	40 watts	/	1050mm